

FF Series

ISO-16028 Flush Face Couplings

The FF Series is a flat face dry break coupling that meets or exceeds the ISO 16028 standard.

Features

- Non-spill / Flush Face Design
- Push to connect
- Sleeve lock standard
- Anti-Blowout Nitrile
- PTFE Bonded Seal

Applications

- Hydraulic tool
- Skidsteer loaders
- Agricultural
- Overhead bucket hoists
- Chemical
- Railway
- Public utilities

Interchangeability

- ISO 16028

Materials

- Zinc Nickel plated steel
- Buna-N seals standard

Sizes

- 1/8" to 1" nominal

Temp. Rating

- -22°F to +230°F

Rated Pressure

- 5000 PSI in sizes 1/8" to 1/2"
- 3625 PSI max. in sizes 3/4" to 1"



FF Series

ISO-16028 Flush Face Couplings

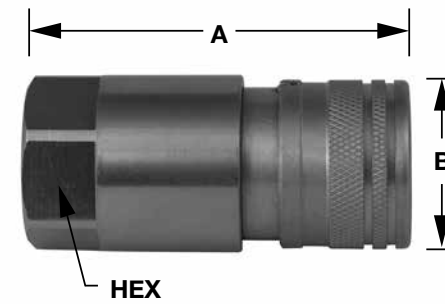

Coupler

BODY SIZE	ISO SIZE	PART NUMBER		DIMENSIONS (IN.)		
		STEEL	THREAD SIZE	A	B	HEX
1/8"	5	FF02-02F-NPT	1/8" NPTF	1.91	.56	.67
1/4"	6.3	FF04-04F-NPT	1/4" NPTF	1.94	1.10	.94
1/4"	6.3	FF04-06F-ORB	9/16"-18 ORB	1.94	1.10	.94
3/8"	10	FF06-06F-NPT	3/8" NPTF	2.69	1.26	.94
3/8"	10	FF06-08F-NPT	1/2" NPTF	2.69	1.26	.94
3/8"	10	FF06-06F-ORB	9/16"-18 ORB	2.97	1.26	.94
3/8"	10	FF06-08F-ORB	3/4"-16 ORB	2.97	1.26	.94
1/2"	12.5	FF08-08F-NPT	1/2" NPTF	2.96	1.49	1.26
1/2"	12.5	FF08-12F-NPT	3/4" NPTF	2.96	1.49	1.26
1/2"	12.5	FF08-10F-ORB	7/8"-14 ORB	3.42	1.49	1.33
1/2"	12.5	FF08-08F-ORB	3/4"-16 ORB	3.42	1.49	1.33
1/2"	12.5	FF08-12F-ORB	1 1/16"-12 ORB	3.42	1.49	1.33
5/8"	16	FF10-08F-NPT	1/2" NPTF	3.16	1.65	1.42
5/8"	16	FF10-12F-NPT	3/4" NPTF	3.16	1.65	1.42
5/8"	16	FF10-10F-ORB	7/8"-14 ORB	3.53	1.65	1.42
5/8"	16	FF10-08F-ORB	3/4" NPTF	3.53	1.65	1.42
5/8"	16	FF10-12F-ORB	1 1/16"-12 ORB	3.53	1.65	1.42
3/4"	19	FF12-12F-NPT	3/4" NPTF	3.93	1.88	1.61
3/4"	19	FF12-16F-NPT	1" NPTF	3.93	1.88	1.61
3/4"	19	FF12-12F-ORB	1 1/16"-12 ORB	4.18	1.88	1.61
3/4"	19	FF12-16F-ORB	1 5/16"-12 ORB	4.18	1.88	1.61
1"	25	FF16-16F-NPT	1" NPTF	4.21	2.16	1.97
1"	25	FF16-20F-NPT	1 1/4" NPTF	4.21	2.16	1.97
1"	25	FF16-20F-ORB	1 5/8"-12 ORB	4.52	2.16	1.97

Performance:

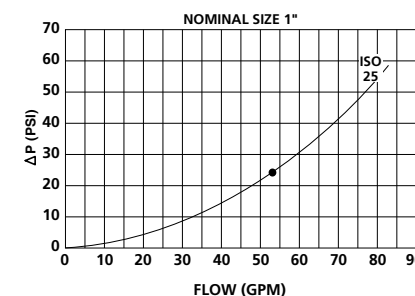
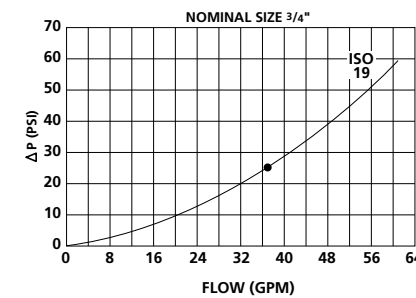
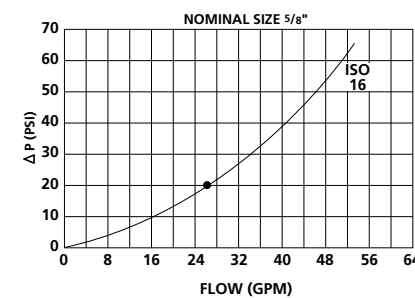
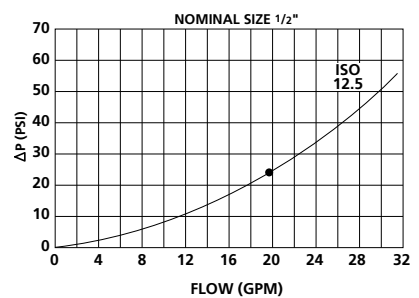
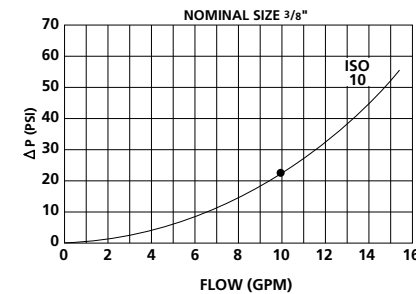
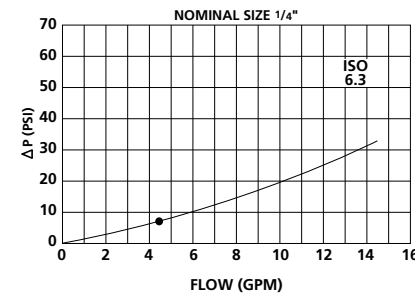
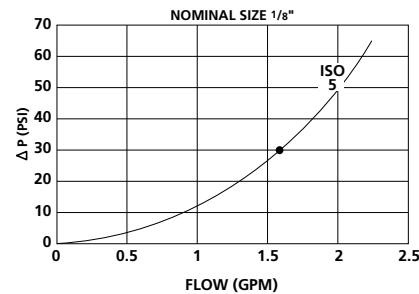

Dust Protector For Coupler - Rubber (Red)

SIZE	ISO SIZE	PART NUMBER
1/4"	6.3	FF04-FC
3/8"	10	FF06-FC
1/2"	12.5	FF08-FC
5/8"	16	FF10-FC
3/4"	19	FF12-FC
1"	25	FF16-FC

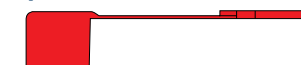

FF Series

ISO-16028 Flush Face Couplings

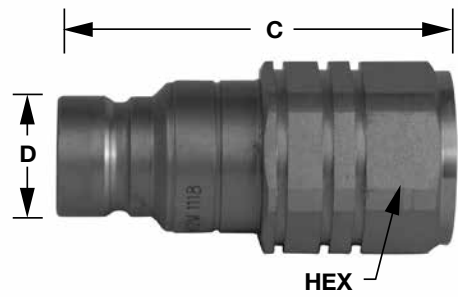

Plug

BODY SIZE	ISO SIZE	PART NUMBER		DIMENSIONS (IN.)		
		STEEL	THREAD SIZE	C	D	HEX
1/8"	5	FF02-02M-NPT	1/8" NPTF	1.52	.46	.67
1/4"	6.3	FF04-04M-NPT	1/4" NPTF	1.94	.63	.78
1/4"	6.3	FF04-06M-ORB	9/16"-18 ORB	1.94	.63	.78
3/8"	10	FF06-06M-NPT	3/8" NPTF	2.18	.77	.95
3/8"	10	FF06-08M-NPT	1/2" NPTF	2.18	.77	.95
3/8"	10	FF06-06M-ORB	9/16"-18 ORB	2.18	.77	.95
3/8"	10	FF06-08M-ORB	3/4"-16 ORB	2.18	.77	.95
1/2"	12.5	FF08-08M-NPT	1/2" NPTF	2.81	.96	1.26
1/2"	12.5	FF10-08M-NPT	3/4" NPTF	2.81	.96	1.26
1/2"	12.5	FF08-12M-NPT	7/8"-14 ORB	2.81	.96	1.26
1/2"	12.5	FF08-10M-ORB	3/4"-16 ORB	2.81	.96	1.26
1/2"	12.5	FF08-08M-ORB	11/16"-12 ORB	2.81	.96	1.26
5/8"	16	FF08-12M-ORB	1/2" NPTF	2.95	1.06	1.42
5/8"	16	FF10-12M-NPT	3/4" NPTF	2.95	1.06	1.42
5/8"	16	FF10-10M-ORB	7/8"-14 ORB	2.95	1.06	1.42
5/8"	16	FF10-08M-ORB	3/4" NPTF	2.95	1.06	1.42
5/8"	16	FF10-12M-ORB	11/16"-12 ORB	2.95	1.06	1.42
3/4"	19	FF12-12M-NPT	3/4" NPTF	3.69	1.17	1.61
3/4"	19	FF12-16M-NPT	1" NPTF	3.69	1.17	1.61
3/4"	19	FF12-12M-ORB	11/16"-12 ORB	3.69	1.17	1.61
3/4"	19	FF12-16M-ORB	15/16"-12 ORB	3.69	1.17	1.61
1"	25	FF16-16M-NPT	1" NPTF	3.54	1.48	2.16
1"	25	FF16-20M-NPT	1 1/4" NPTF	3.54	1.48	2.16
1"	25	FF16-20M-ORB	1 5/8"-12 ORB	3.54	1.48	2.16

Dust Protector For Plug - Rubber (Red)

SIZE	ISO SIZE	PART NUMBER
1/4"	6.3	FF04-MC
3/8"	10	FF06-MC
1/2"	12.5	FF08-MC
5/8"	16	FF10-MC
3/4"	19	FF12-MC
1"	25	FF16-MC



FF Series

ISO-16028-5675 Combination Couplings

Features

- Non-spill by poppet combination
- Easily adapt farm implements to use with a skid steer
- 1/2" body size
- Push to connect
- Sleeve lock standard
- Zinc nickel plated
- 5,000 PSI rated pressure



FF Coupler Half X NV Poppet Plug Half

BODY SIZE	ISO SIZE	END CONNECTIONS	PART NUMBER	A	B
1/2"	12.5	FEMALE FLUSH FACE X MALE NV	FF08-N12F/NV-12-M	4.25	1.49

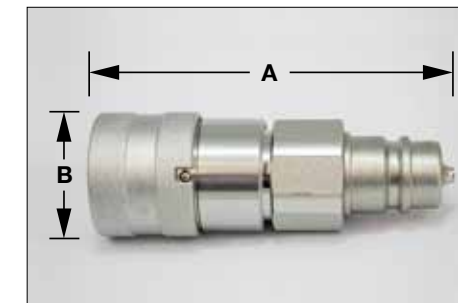

Dust Protector For Female Side - Rubber (Red)

SIZE	ISO SIZE	PART NUMBER
1/2"	12.5	FF08-FC



Dust Protector For Male Side - Rubber (Red)

SIZE	ISO SIZE	PART NUMBER
1/2"	12.5	TF-12-R



FF Plug Half X NV Poppet Coupler Half

BODY SIZE	ISO SIZE	END CONNECTIONS	PART NUMBER	A	B
1/2"	12.5	MALE FLUSH FACE X FEMALE NV	FF08-N12M/NV-12-F	4.15	1.49

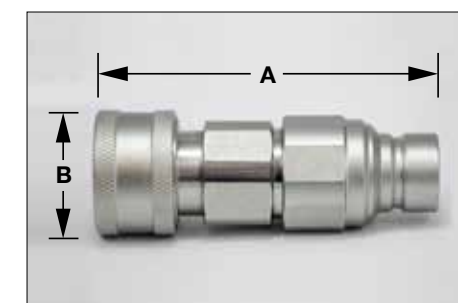

Dust Protector For Female Side - Rubber (Red)

SIZE	ISO SIZE	PART NUMBER
1/2"	12.5	TM-12-R



Dust Protector For Male Side - Rubber (Red)

SIZE	ISO SIZE	PART NUMBER
1/2"	12.5	FF08-MC



FFS Series

ISO-16028 Flush Face Couplings – 316 Stainless Steel

Features

- Non-spill/flush face design
- Push to connect
- Sleeve lock standard
- Anti-blowout nitrile PTFE bonded seats
- FKM O-rings
- 1/4" to 3/4" body sizes, ISO sizes 6.3-19

Rated Pressure

- 1/4" 5075 PSI
- 3/8"-3/4" 3625 PSI



Coupler

BODY SIZE	ISO SIZE	PART NUMBER	THREAD SIZE	A	B	HEX
1/4"	6.3	FFS04-N14F	1/4" NPTF	2.44	1.10	1.06
3/8"	10	FFS06-N38F	3/8" NPTF	2.89	1.26	1.18
3/8"	10	FFS06-N12F	1/2" NPTF	2.89	1.26	1.18
3/8"	10	FFS06-S916F	9/16"-18 ORB	2.89	1.26	1.18
3/8"	10	FFS06-S34F	3/4"-16 ORB	2.89	1.26	1.18
1/2"	12.5	FFS08-N12F	1/2" NPTF	3.43	1.49	1.61
1/2"	12.5	FFS08-N34F	3/4" NPTF	3.43	1.49	1.61
1/2"	12.5	FFS08-S34F	3/4"-16 ORB	3.43	1.49	1.61
1/2"	12.5	FFS08-S116F	11/16"-12 ORB	3.43	1.49	1.61
1/2"	12.5	FFS08-S78F	7/8"-14 ORB	3.43	1.49	1.61
3/4"	19	FFS12-N34F	3/4" NPTF	3.84	1.88	1.81
3/4"	19	FFS12-N1F	1 NPTF	3.84	1.88	1.81
3/4"	19	FFS12-S1516F	15/16"-12 ORB	3.84	1.88	1.81

For dust caps, refer to page 2.



Plug

BODY SIZE	ISO SIZE	PART NUMBER	THREAD SIZE	A	B	HEX
1/4"	6.3	FFS04-N14M	1/4" NPTF	2.06	.63	.87
3/8"	10	FFS06-N38M	3/8" NPTF	2.46	.77	1.18
3/8"	10	FFS06-N12M	1/2" NPTF	2.46	.77	1.18
3/8"	10	FFS06-S916M	9/16"-18 ORB	2.46	.77	1.18
3/8"	10	FFS06-S34M	3/4"-16 ORB	2.46	.77	1.18
1/2"	12.5	FFS08-N12M	1/2" NPTF	2.87	.96	1.42
1/2"	12.5	FFS08-N34M	3/4" NPTF	2.87	.96	1.42
1/2"	12.5	FFS08-S34M	3/4"-16 ORB	2.87	.96	1.42
1/2"	12.5	FFS08-S116M	11/16"-12 ORB	2.87	.96	1.42
1/2"	12.5	FFS08-S78M	7/8"-14 ORB	2.87	.96	1.42
3/4"	19	FFS12-N34M	3/4" NPTF	3.39	1.17	1.61
3/4"	19	FFS12-N1M	1 NPTF	3.39	1.17	1.61
3/4"	19	FFS12-S1516M	15/16"-12 ORB	3.39	1.17	1.61

For dust caps, refer to page 3.

3FF Series

ISO-16028 Connect Under Pressure Plugs

Features

- Non-spill/flush face design
- Push to connect
- Connect under pressure up to 3,000 PSI

Interchangeability

- ISO-16028

Material

- QPQ plated steel

Size

- 1/4" to 1" Nominal

Temp Rating

- -22°F to +230°F

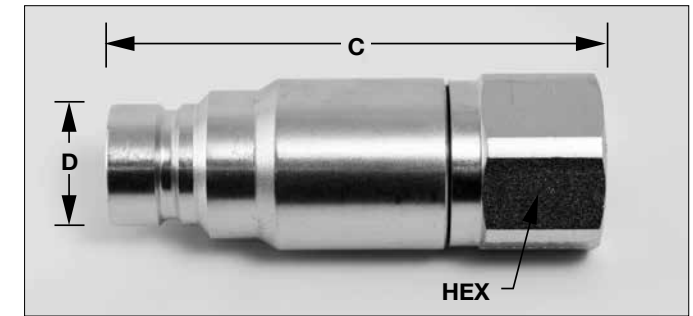

Plug

BODY SIZE	ISO SIZE	PART NUMBER		DIMENSIONS (IN.)		
		STEEL	THREAD SIZE	C	D	HEX
1/4"	6.3	3FF04-N14M	1/4" NPTF	3.02	.64	.79
3/8"	10	3FF06-N38M	3/8" NPTF	3.07	.78	.95
3/8"	10	3FF06-N12M	1/2" NPTF	3.07	.78	.95
3/8"	10	3FF06-S916M	9/16"-18 ORB	3.07	.78	.95
3/8"	10	3FF06-S34M	3/4"-16 ORB	3.07	.78	.95
1/2"	12.5	3FF08-N12M	1/2" NPTF	3.77	.97	1.26
1/2"	12.5	3FF08-S34M	1/4" NPTF	3.77	.97	1.26
1/2"	12.5	3FF08-S78M	7/8"-14 ORB	3.77	.97	1.26
1/2"	12.5	3FF08-S1116M	11/16"-12 ORB	3.77	.97	1.26
3/4"	19	3FF12-N34M	3/4" NPTF	4.48	1.18	1.81
3/4"	19	3FF12-S1116M	11/16"-12 ORB	4.48	1.18	1.81
1"	25	3FF16-N1M	1" NPTF	4.87	1.41	2.17
1"	25	3FF16-S1516M	15/16"-12 ORB	4.87	1.41	2.17

Dust Protector For Plug - Rubber (Red)

SIZE	ISO SIZE	PART NUMBER
1/4"	6.3	FF04-MC
3/8"	10	FF06-MC
1/2"	12.5	FF08-MC
3/4"	19	FF12-MC
1"	25	FF16-MC



Technical Information

SIZE	WORKING PRESSURE	FLOW- GPM	MAX. RESIDUAL PRESSURE	SPILLAGE
1/4"	5000 PSI	8	3000 PSI	0.010 mL
3/8"	4350 PSI	12	3000 PSI	0.010 mL
1/2"	4350 PSI	24	2750 PSI	0.010 mL
3/4"	3625 PSI	53	2200 PSI	0.120 mL
1"	3000 PSI	80	1800 PSI	0.200 mL

FF90 Series

ISO-16028-90° Couplings

Features

- 90° connection angle to prevent hose damage
- No need for additional fittings
- Locking sleeve standard
- Zinc nickel plating standard
- Minimal spillage and air inclusion
- ISO-16028 interchange



Coupler

BODY SIZE	ISO SIZE	PART NUMBER	THREAD SIZE	A	B	HEX
1/2"	12.5	FF90-S916FJ	#6 JIC	3.60	1.49	1.42
1/2"	12.5	FF90-S34FJ	#12 JIC	3.60	1.49	1.42

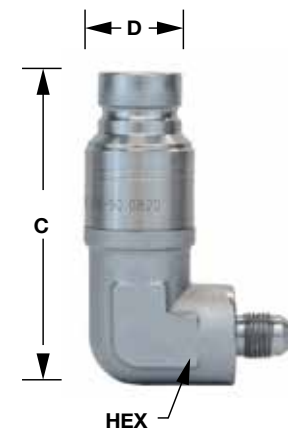

Plug

BODY SIZE	ISO SIZE	PART NUMBER	THREAD SIZE	C	D	HEX
1/2"	12.5	FF90-S916MJ	#6 JIC	3.60	.96	1.16
1/2"	12.5	FF90-S34MJ	#12 JIC	3.60	.96	1.16

Dust Protector For Coupler

SIZE	ISO SIZE	PART NUMBER
1/2"	12.5	FF08-FC



Dust Protector For Plug

SIZE	ISO SIZE	PART NUMBER
1/2"	12.5	FF08-MC



BC Series

Flush Face Replacement Couplings

Features

- Non-spill/flush face design
- Direct interchange to Faster, Holmbury and Summit Brands
- Compatible with ISO-16028 specifications
- Connectable under pressure
- Zinc nickel plated
- 5075 PSI rated
- Coupler half replaces Bobcat #7246802
- Plug half replaces Bobcat #7246799
- Will fit into any manifold block with either FFH or FFI stamped on it



Coupler

BODY SIZE	ISO SIZE	THREAD	PART NUMBER	MATERIAL
1/2"	12.5	48mm	PC-BC-08F-RC-1/2"	STEEL

Dust Protector For Coupler

SIZE	ISO SIZE	PART NUMBER
1/2"	12.5	FF08-FC



Plug

BODY SIZE	ISO SIZE	THREAD	PART NUMBER	MATERIAL
1/2"	12.5	48mm	PC-BC-08M-RC-1/2"	STEEL

Dust Protector For Plug

SIZE	ISO SIZE	PART NUMBER
1/2"	12.5	FF08-MC



HNV Series

ISO-B Industrial Interchange

Features

- Industry wide interchange
- High flow capacity
- Positive valve stop
- Bubble tight sealing
- Buna-N O-Rings
- PTFE backup rings

Applications

- Hydraulic
- Chemical
- Steam
- Vacuum
- Transportation
- Fluid transfer

Interchangeability

- ISO 7241-I Series B
- Parker
- Aeroquip
- Safeway
- Faster
- Dixon
- DNP
- Stucchi

Materials

- Steel
- Brass
- 316 Stainless

Sizes

- 1/8" to 1"

Temp. Rating

- -22°F to +230°F



Rated Pressure (PSI)

BODY SIZE	STEEL	BRASS	316 SS
1/8"	4650	4300	5000
1/4"	4100	2900	3500
3/8"	3780	2900	3000
1/2"	3780	2650	2000
3/4"	3045	2000	1500
1"	3045	2000	1500

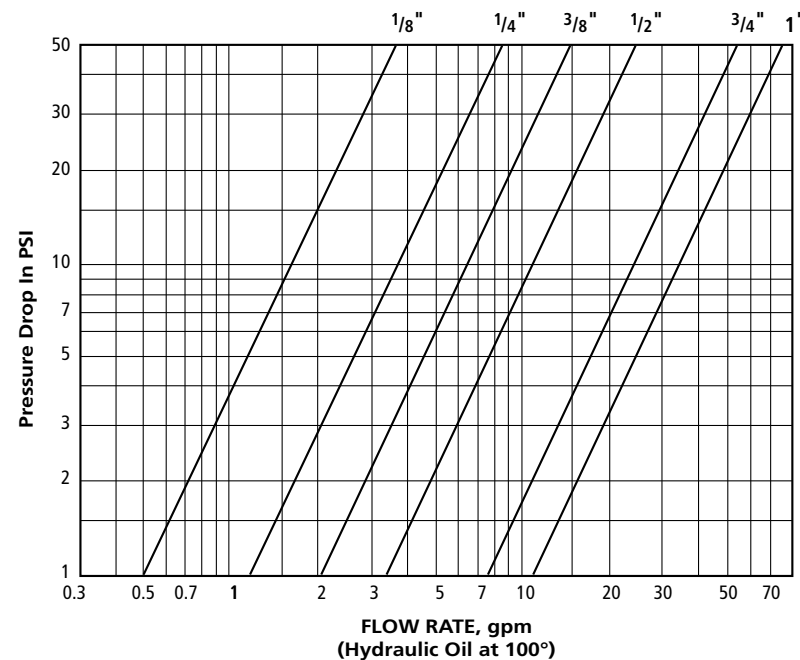

HNV Series

ISO-B 1/8"-1" Sizes

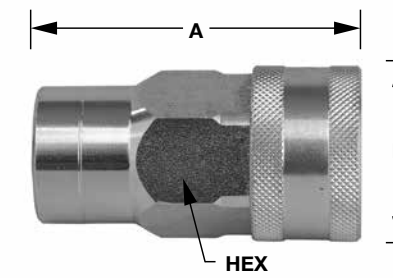

Coupler (NPT)

BODY SIZE	PART NUMBER			THREAD	STEEL DIMENSIONS (IN.)		
	STEEL	BRASS	316 STAINLESS		A	B	HEX
1/8"	HNV-18-F	HNV-18-F-5	N/A	1/8" NPTF	1.93	.87	.56
1/4"	HNV-14-F	HNV-14-F-5	HNV-14-F-3	1/4" NPTF	2.26	1.06	.75
3/8"	HNV-38-F	HNV-38-F-5	HNV-38-F-3	3/8" NPTF	2.62	1.38	.94
1/2"	HNV-12-F	HNV-12-F-5	HNV-12-F-3	1/2" NPTF	2.91	1.65	1.06
3/4"	HNV-34-F	HNV-34-F-5	HNV-34-F-3	3/4" NPTF	3.58	2.05	1.42
1"	HNV-1-F	HNV-1-F-5	HNV-1-F-3	1" NPTF	4.10	2.36	1.61

Note: Contact PCI for brass and stainless dimensions

Coupler (ORB)

BODY SIZE	PART NUMBER		DIMENSIONS (IN.)		
	STEEL	THREAD	A	B	HEX
3/8"	HNV-38-SAE-F	3/4" -16 ORB	2.62	1.38	.94
1/2"	HNV-12-SAE-F	7/8" -14 ORB	2.91	1.65	1.06
3/4"	HNV-34-SAE-F	1 1/16" -12 ORB	3.54	2.05	1.42
1"	HNV-1-SAE-F	1 5/16" -12 ORB	4.06	2.36	1.61

Dust Protector For Coupler (Red)

BODY SIZE	PART NUMBER	
	RUBBER	
1/8"	TMH-18	
1/4"	TMH-14	
3/8"	TMH-38	
1/2"	TMH-12	
3/4"	TMH-34	
1"	TMH-1	



HNV Series

ISO-B 1/8"-1" Sizes

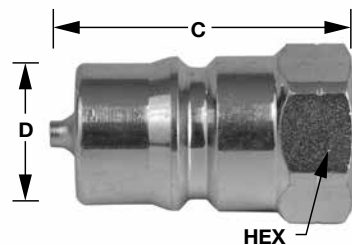

Plug (NPT)

BODY SIZE	PART NUMBER			THREAD	STEEL DIMENSIONS (IN.)		
	STEEL	BRASS	316 STAINLESS		C	D	HEX
1/8"	HNV-18-M	HNV-18-M-5	N/A	1/8" NPTF	1.18	.43	.55
1/4"	HNV-14-M	HNV-14-M-5	HNV-14-M-3	1/4" NPTF	1.41	.56	.75
3/8"	HNV-38-M	HNV-38-M-5	HNV-38-M-3	3/8" NPTF	1.59	.76	.94
1/2"	HNV-12-M	HNV-12-M-5	HNV-12-M-3	1/2" NPTF	1.81	.92	1.06
3/4"	HNV-34-M	HNV-34-M-5	HNV-34-M-3	3/4" NPTF	2.20	1.26	1.41
1"	HNV-1-M	HNV-1-M-5	HNV-1-M-3	1" NPTF	2.48	1.48	1.61

Note: Contact PCI for brass and stainless dimensions

Plug (ORB)

BODY SIZE	PART NUMBER		DIMENSIONS (IN.)		
	STEEL	THREAD	C	D	HEX
3/8"	HNV-38-SAE-M	3/4" -16 ORB	1.59	.76	.94
1/2"	HNV-12-SAE-M	7/8" -14 ORB	1.81	.92	1.06
3/4"	HNV-34-SAE-M	1 1/16" -12 ORB	2.20	1.26	1.41
1"	HNV-1-SAE-M	1 5/16" -12 ORB	2.48	1.48	1.61

Dust Protector For Plug (Red)

BODY SIZE	PART NUMBER	
	RUBBER	
1/8"	TFH-18	
1/4"	TFH-14	
3/8"	TFH-38	
1/2"	TFH-12	
3/4"	TFH-34	
1"	TFH-1	



ANV Series

ISO-A Interchange

Features

- Ball lock
- Manual connect/disconnect
- Poppet valving
- Slim profile
- Zinc plated steel

Applications

- Construction
- Agricultural
- General industry
- Fluid transfer

Interchangeability

- ISO 7241-I Series A

Materials

- Zinc plated steel
- Stainless Steel spring, balls and retaining ring
- Buna-N seals

Sizes

- 1/4" to 2"

Temp. Rating

- -4°F to +212°F



Rated Pressure

SIZE	PSI
1/4"	5000
3/8"	4000
1/2"	4000
3/4"	3000
1"	3000
1 1/4"	3625
1 1/2"	2900
2"	2755

Performance:

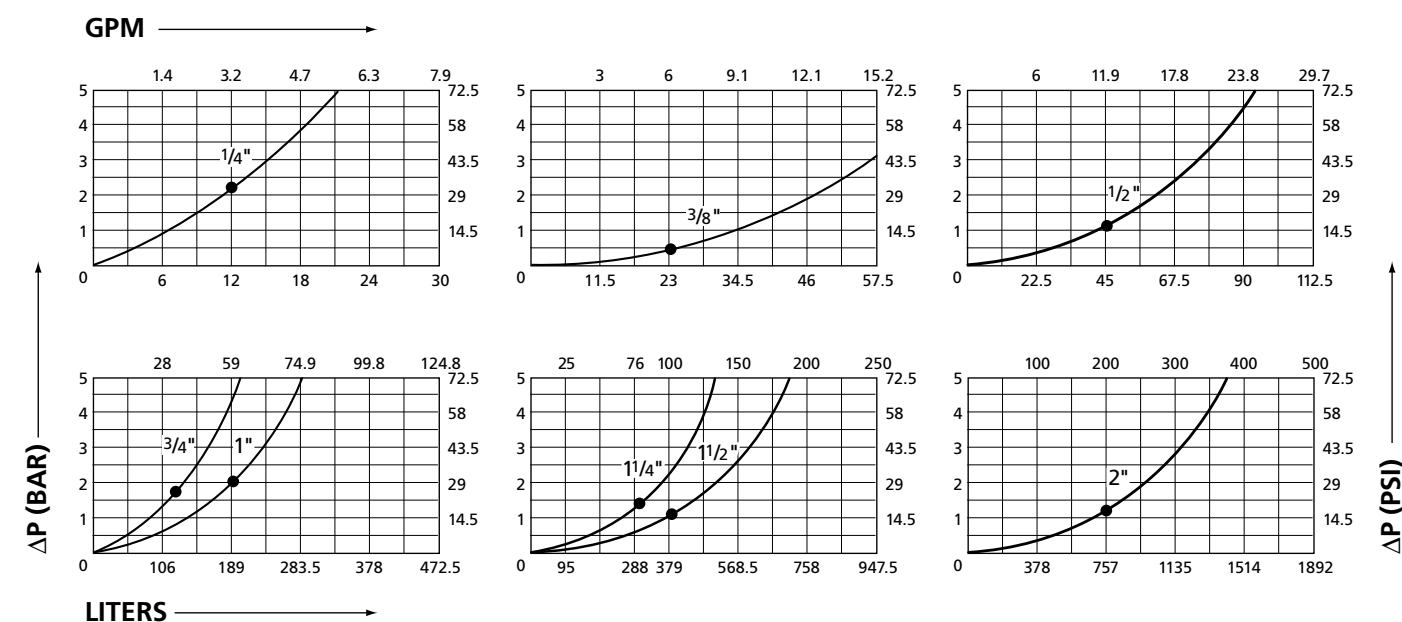

ANV Series

ISO-A 1/4"-2"

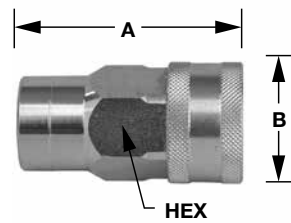

BODY SIZE	PART NUMBER		DIMENSIONS (IN.)		
	STEEL	THREAD SIZE	A	B	HEX
1/4"	ANV-14-F	1/4" NPTF	2.05	1.02	.75
3/8"	ANV-38-F	3/8" NPTF	2.30	1.26	.94
3/8"	ANV-38-SAE-F	9/16"-18 ORB	2.30	1.26	.94
1/2"	NV-12-F	1/2" NPTF	2.50	1.49	1.18
1/2"	NV-12-SAE-F	3/4"-16 ORB	2.50	1.49	1.18
1/2"	NV-12/78-SAE-F	7/8"-14 ORB	2.50	1.49	1.18
3/4"	ANV-34-F	3/4" NPTF	3.29	1.81	1.49
3/4"	ANV-34-SAE-F	11/16"-12 ORB	3.29	1.81	1.49
1"	ANV-1-F	1" NPTF	3.82	2.17	1.81
1"	ANV-1-SAE-F	15/16"-12 ORB	3.82	2.17	1.81
1 1/4"	ANV-114-F	1 1/4" NPTF	4.61	2.76	1.97
1 1/2"	ANV-112-F	1 1/2" NPTF	5.24	3.33	2.36
2"	ANV-2-F	2" NPTF	6.50	3.94	2.95

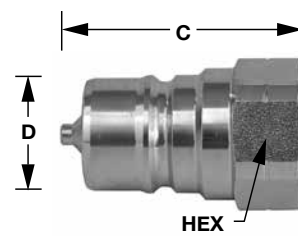

BODY SIZE	PART NUMBER		DIMENSIONS (IN.)		
	STEEL	THREAD SIZE	C	D	HEX
1/4"	ANV-14-M	1/4" NPTF	1.49	.47	.75
3/8"	ANV-38-M	3/8" NPTF	1.59	.68	.86
3/8"	ANV-38-SAE-M	9/16"-18 ORB	1.59	.68	.84
1/2"	NV-12-M	1/2" NPTF	1.81	.81	1.06
1/2"	2NV-12-SAE-M*	3/4"-16 ORB	1.81	.81	1.06
1/2"	NV-12/78-SAE-M	7/8"-14 ORB	1.92	.81	1.03
3/4"	ANV-34-M	3/4" NPTF	2.20	1.14	1.41
3/4"	ANV-34-SAE-M	11/16"-12 ORB	2.20	1.14	1.43
1"	ANV-1-M	1" NPTF	2.48	1.35	1.61
1"	ANV-1-SAE-M	1 5/16"-12 ORB	2.48	1.35	1.58
1 1/4"	ANV-114-M	1 1/4" NPTF	2.95	1.77	1.97
1 1/2"	ANV-112-M	1 1/2" NPTF	3.29	2.16	2.36
2"	ANV-2-M	2" NPTF	4.13	2.56	2.95

* Connectable under pressure.

Dust Protector For Coupler (Red)

SIZE	PART NUMBER
1/4"	TMA-14
3/8"	TMA-38
1/2"	TM-12-R
3/4"	TMA-34
1"	TMA-1
1 1/4"	TMA-114
1 1/2"	TMA-112
2"	TMA-2



Dust Protector For Plug (Red)

SIZE	PART NUMBER
1/4"	TFA-14
3/8"	TFA-38
1/2"	TF-12-R
3/4"	TFA-34
1"	TFA-1
1 1/4"	TFA-114
1 1/2"	TFA-112
2"	TFA-2



NS/NV Series

ISO-5675 Agricultural Couplings

Features

- ISO 5675 interchange
- High concentration of locking balls
- Ball or poppet valving

Applications

- Construction
- Agricultural
- Forestry
- Oil tools
- Steel mill machinery
- Fluid transfer

Interchangeability

- Parker • Dixon
- Safeway • DNP
- Faster • Stucchi

Materials

- Steel

Sizes - Ball Type

- 1/4" to 3/4"

Sizes - Poppet Type

- 1/4" to 1"

Temp. Rating

- -22°F to +230°F



Rated Pressure (PSI) - Ball Type

SIZE	STEEL
1/4"	5000
3/8"	4350
1/2"	4350
3/4"	3625

Rated Pressure (PSI) - Poppet Type

SIZE	STEEL
1/4"	5000
3/8"	4350
1/2"	4350
1"	3200

Performance:

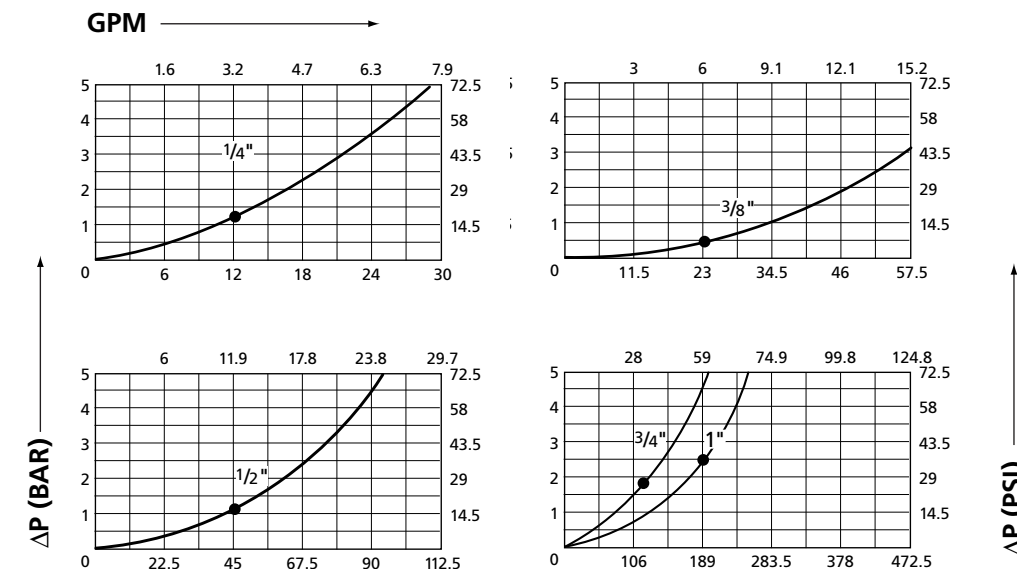

NS Series

ISO-5675 Ball Type Couplings

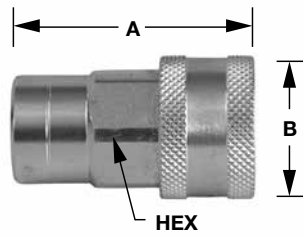

Dust Protector For Coupler

SIZE	PART NUMBER	COLOR
1/4"	TM-14-R	RED
3/8"	TM-38-R	RED
1/2"	TM-12	BLACK
1/2"	TM-12-R	RED
1/2"	TM-12-B	BLUE
1/2"	TM-12-G	GREEN
1/2"	TM-12-Y	YELLOW

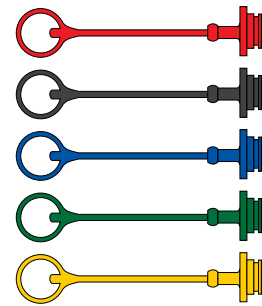

Coupler			DIMENSIONS (IN.)		
BODY SIZE	STEEL	THREAD	A	B	HEX
1/4"	NS-14-F	1/4" NPTF	2.11	1.06	.75
3/8"	NS-38-F	3/8" NPTF	2.40	1.38	.94
1/2"	NS-12-F	1/2" NPTF	2.50	1.50	1.06
3/4"	NSP-34-F	3/4" NPTF	3.34	1.79	1.41

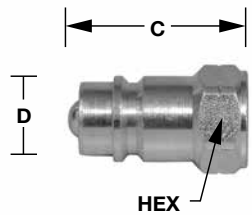

Dust Protector For Plug

SIZE	PART NUMBER	COLOR
1/4"	TF-14-R	RED
3/8"	TF-38-R	RED
1/2"	TF-12	BLACK
1/2"	TF-12-R	RED
1/2"	TF-12-B	BLUE
1/2"	TF-12-G	GREEN
1/2"	TF-12-Y	YELLOW

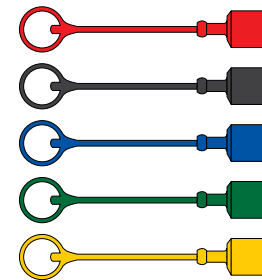

Plug			DIMENSIONS (IN.)		
BODY SIZE	STEEL	THREAD	C	D	HEX
1/4"	NS-14-M	1/4" NPTF	1.42	.55	.75
3/8"	NS-38-M	3/8" NPTF	1.59	.75	.94
1/2"	**2NS-12-M	1/2" NPTF	1.81	.80	1.06
3/4"	NSP-34-M	3/4" NPTF	2.20	1.10	1.41

** Connectable under pressure. (Up to 2750 PSI)

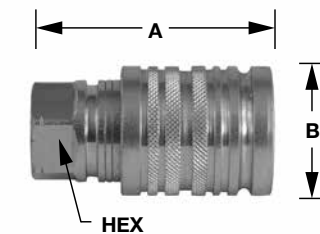

Dust Protector For Coupler

SIZE	PART NUMBER	COLOR
1/2"	TM-12	BLACK
1/2"	TM-12-R	RED
1/2"	TM-12-B	BLUE
1/2"	TM-12-G	GREEN
1/2"	TM-12-Y	YELLOW

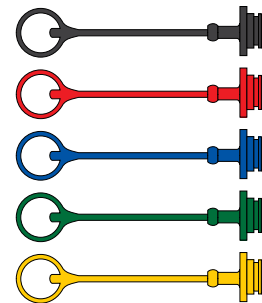

Double Acting Sleeve Coupler			DIMENSIONS (IN.)		
BODY SIZE	STEEL	THREAD	A	B	HEX
1/2"	PS-12-F	1/2" NPTF	2.50	1.50	1.06

NV Series

ISO-5675 Poppet Type Couplings

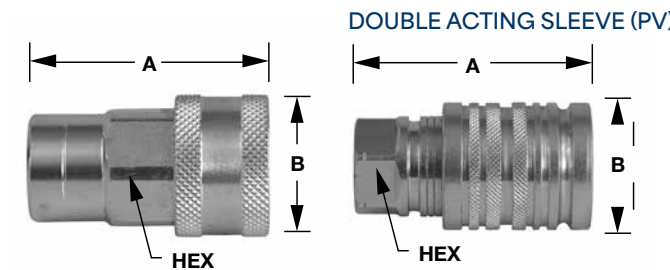

Dust Protector For Coupler

SIZE	PART NUMBER	COLOR
1/4"	TM-14-R	RED
3/8"	TM-38-R	RED
1/2"	TM-12	BLACK
1/2"	TM-12-R	RED
1/2"	TM-12-B	BLUE
1/2"	TM-12-G	GREEN
1/2"	TM-12-Y	YELLOW

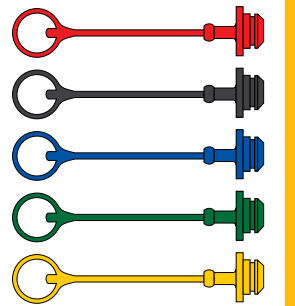

Coupler			DIMENSIONS (IN.)		
BODY SIZE	STEEL	THREAD SIZE	A	B	HEX
1/4"	NV-14-F	1/4" NPTF	2.11	1.06	.75
3/8"	NV-38-F	3/8" NPTF	2.40	1.38	.94
1/2"	NV-12-F	1/2" NPTF	2.50	1.50	1.06
1/2"	NV-12-SAE-F	3/4" -16 ORB	2.76	1.50	1.06
1/2"	NV-12/78-SAE-F	7/8" -14 ORB	2.76	1.50	1.06
1/2"	PV-12-F	1/2" NPTF	2.50	1.50	1.06
1/2"	PV-12-SAE-F	3/4" -16 ORB	2.50	1.50	1.06
1/2"	PV-12/34-F	3/4" NPTF	2.50	1.50	1.06
1"	NV-1-F	1" NPTF	3.86	2.01	1.61

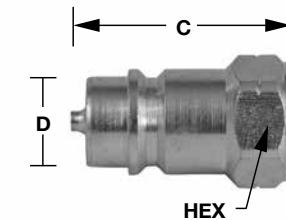

Dust Protector For Plug

SIZE	PART NUMBER	COLOR
1/4"	TF-14-R	RED
3/8"	TF-38-R	RED
1/2"	TF-12	BLACK
1/2"	TF-12-R	RED
1/2"	TF-12-B	BLUE
1/2"	TF-12-G	GREEN
1/2"	TF-12-Y	YELLOW

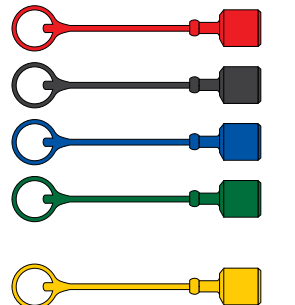

Plug			DIMENSIONS (IN.)		
BODY SIZE	STEEL	THREAD SIZE	C	D	HEX
1/4"	NV-14-M	1/4" NPTF	1.42	.55	.75
3/8"	NV-38-M	3/8" NPTF	1.59	.75	.94
1/2"	NV-12-M	1/2" NPTF	1.81	.80	1.06
1/2"	*2NV-12-M	1/2" NPTF	1.81	.80	1.06
1/2"	NV-12/34-M	3/4" NPTF	1.81	.80	1.34
1/2"	*2NV-12-SAE-M	3/4" -16 ORB	1.81	1.06	1.06
1/2"	NV-12/78-SAE-M	7/8" -14 ORB	1.81	1.06	1.06
1"	NV-1-M	1" NPTF	2.88	1.23	1.61

* Connectable under pressure. (Up to 2750 PSI)

FB Series

Wing Nut Couplings

Features

- Connect/disconnect under pressure
- Brass construction
- O-ring connected marker

Applications

- Wet line hydraulic systems
- Oil field
- Mobile drilling rigs
- Submersible pumps

Interchangeability

- Parker
- Aeroquip
- Faster
- Dixon
- DNP
- Stucchi

Materials

- Brass

Sizes

- 1/2" to 1-1/2"

Temp. Rating

- -22°F to +230°F

Rated Pressure

- 1/2" to 1" 3000 PSI
- 1-1/4" to 1-1/2" 2750 PSI



FB Series

Wing Nut Couplings

Coupler

BODY SIZE	PART NUMBER		DIMENSIONS (IN.)		
	STEEL	THREAD SIZE	A	B	HEX
3/4"	FB-08-F	1/2" NPTF	3.09	1.92	1.15
3/4"	FB-12-F	3/4" NPTF	3.09	1.92	1.15
1"	FB-16-F	1" NPTF	3.78	2.25	1.44
1 1/4"	FB-20-F	1 1/4" NPTF	3.97	2.62	1.78
1 1/2"	FB-24-F	1 1/2" NPTF	4.06	2.85	2.00

Wing Style

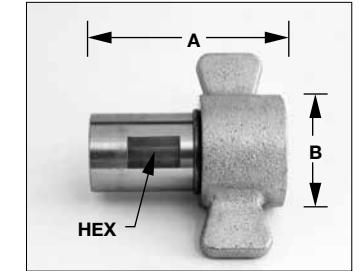

Dust Protector For Coupler (Brass)

BODY SIZE	PART NUMBER
3/4"	FBM-12
1"	FBM-16
1 1/4"	FBM-20
1 1/2"	FBM-24

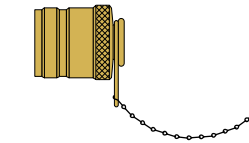

BRASS CAP WITH STAINLESS CHAIN

Performance:

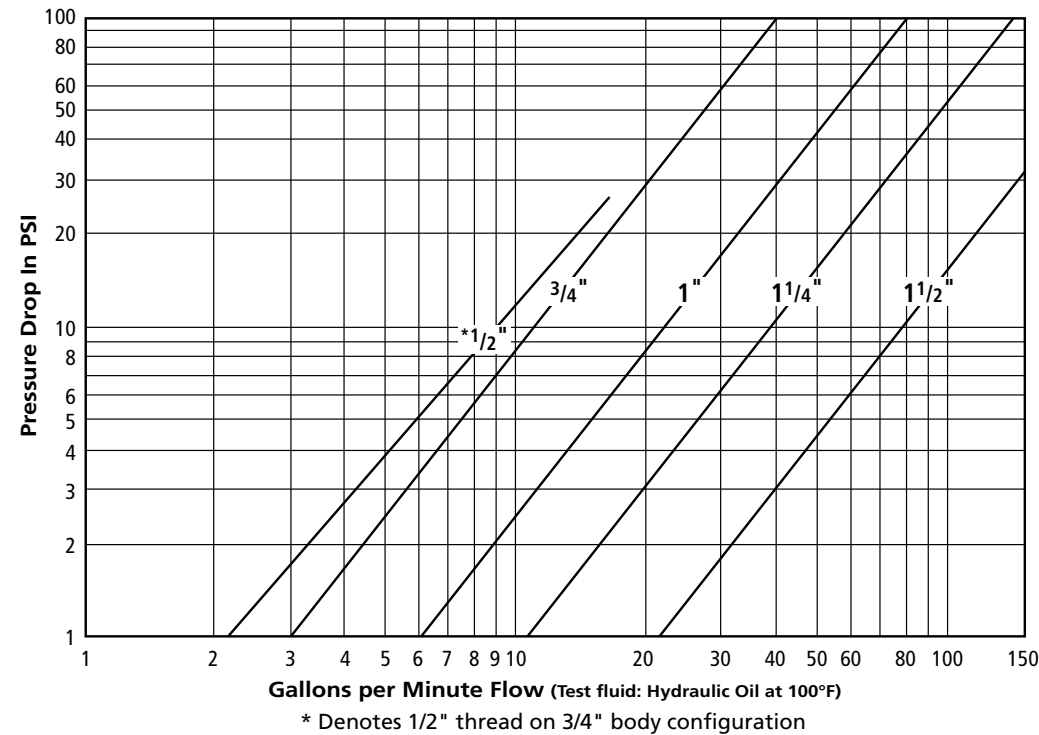

Plug

BODY SIZE	PART NUMBER		DIMENSIONS (IN.)		
	STEEL	THREAD SIZE	D	E	F
3/4"	FB-08-M	1/2" NPTF	3.10	1.31	1.62
3/4"	FB-12-M	3/4" NPTF	3.10	1.31	1.62
1"	FB-16-M	1" NPTF	3.55	1.56	1.87
1 1/4"	FB-20-M	1 1/4" NPTF	3.71	1.88	2.12
1 1/2"	FB-24-M	1 1/2" NPTF	4.06	2.00	2.51

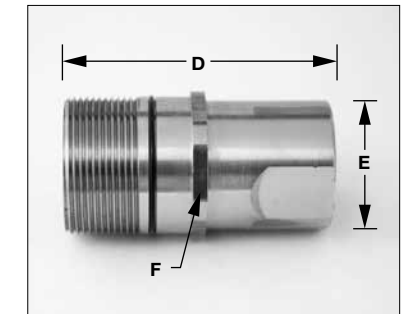

Dust Protector For Plug (Brass)

BODY SIZE	PART NUMBER
3/4"	FBF-12
1"	FBF-16
1 1/4"	FBF-20
1 1/2"	FBF-24

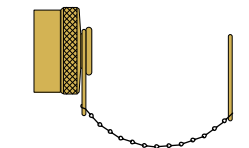

BRASS CAP WITH STAINLESS CHAIN

VVP Series

Heavy Duty Service Couplings

Features

- Connect/disconnect under pressure
- Heavy-duty construction
- O-Ring connected marker
- Unique thread profile for smooth operation
- Ideal for systems experiencing pressure spikes

Applications

- Hydraulic
- Fluid transfer
- Heavy industrial
- Construction
- High impulse

Interchangeability

- Voswinkel HS
- DNP PVV3
- Dixon CVV

Materials

- Steel

Body Sizes

- 3/8" to 1"

Temp. Rating

- -40°F to 240°F



Rated Pressure - PSI

SIZE	STEEL
3/8"	5075
1/2"	4700
3/4"	3675
1"	3675

Performance:

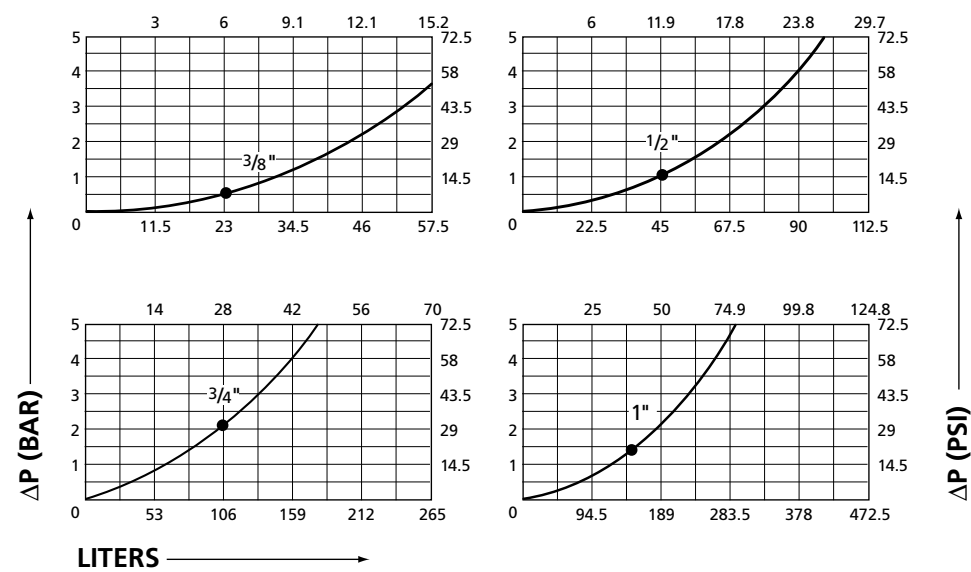

VVP Series

Heavy-Duty Service Couplings

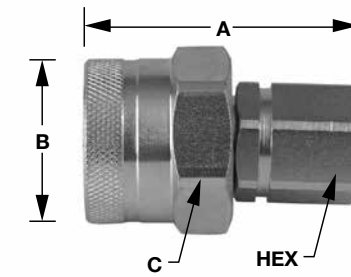

Dust Protector For Coupler (Red)

SIZE	PART NUMBER
3/8"	VVM-38-R
1/2"	VVM-12-R
3/4"	VVM-34-R
1"	VVM-1-R



Coupler

BODY SIZE	PART NUMBER		DIMENSIONS (IN.)			
	STEEL	THREAD SIZE	A	B	C	HEX
3/8"	VVP-38-38-F	3/8" NPTF	2.41	1.35	1.18	.86
3/8"	VVP-38-SAE-F	9/16" -18 ORB	2.41	1.35	1.18	.86
1/2"	VVP-12-12-F	1/2" NPTF	2.64	1.66	1.41	1.06
3/4"	VVP-34-34-F	3/4" NPTF	3.14	1.88	1.61	1.42
1"	VVP-1-1-F	1" NPTF	3.45	2.18	1.96	1.61

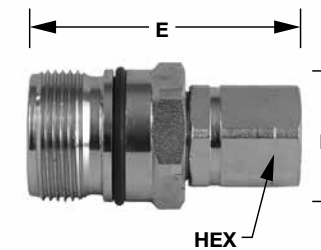

Dust Protector For Plug (Red)

SIZE	PART NUMBER
3/8"	VVF-38-R
1/2"	VVF-12-R
3/4"	VVF-34-R
1"	VVF-1-R



Plug

BODY SIZE	PART NUMBER		DIMENSIONS (IN.)		
	STEEL	THREAD SIZE	E	F	HEX
3/8"	VVP-38-38-M	3/8" NPTF	2.52	1.07	.87
3/8"	VVP-38-SAE-M	9/16" -18 ORB	2.52	1.07	.87
1/2"	VVP-12-12-M	1/2" NPTF	2.76	1.40	1.06
3/4"	VVP-34-34-M	3/4" NPTF	3.39	1.64	1.42
1"	VVP-1-1-M	1" NPTF	3.94	1.90	1.61

PVEP Series

Screw Together Couplings

Features

- Connect/disconnect under pressure up to 4350 PSI
- Improved corrosion resistance
- Two stage valve protects sealing components during pressurized connection and disconnection
- Flush face design avoids fluid loss and air inclusion

Applications

- Excavators
- Grapples
- Hammers
- Construction Equipment
- Oil Field

Interchangeability

- Stucchi VEP
- DNP PST4
- Parker FET

Materials

- Steel with QPQ Plating

Temp. Rating

- -22°F to 230°F



Rated Pressure - PSI

SIZE	PSI
1/2"	5500
3/4"	5000
1"	5000
1 1/4"	5000

Performance:

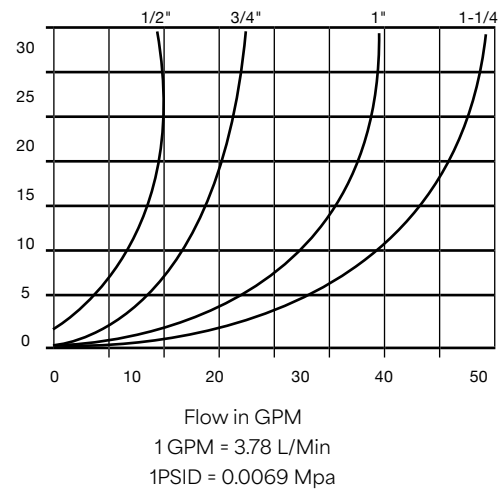

Correct Procedure To Connect And Disconnect The PVEP Series

1. Clean all mating surfaces thoroughly, then pull socket sleeve forward.
2. Align socket and plug, pushing/turning the socket sleeve towards the plug while engaging the threads. Allow threads to pull socket into the plug.
3. Initial connection should be hand threaded, followed by a wrench.
4. Continue to thread socket sleeve into plug until end of sleeve meets plug body.
5. To disconnect, use a wrench to break sleeve free and keep socket and plug aligned.

PVEP Series

Screw Together Couplings

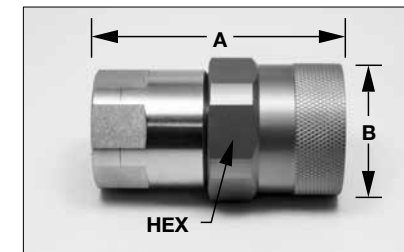

Coupler

BODY SIZE	PART NUMBER		DIMENSIONS (IN.)		
	STEEL	THREAD SIZE	A	B	HEX
1/2"	PVEP-12F-NPT-1/2"	1/2" NPTF	3.08	1.81	1.42
1/2"	PVEP-12F-SAE-3/4"-16	3/4" -16 ORB	3.08	1.81	1.42
3/4"	PVEP-34F-NPT-3/4"	3/4" NPTF	3.34	1.97	1.61
3/4"	PVEP-34F-SAE-1-1/16"	1 1/16" -12 ORB	3.34	1.97	1.61
1"	PVEP-1F-NPT-1"	1" NPTF	3.93	2.17	1.80
1"	PVEP-1F-SAE-1-5/16"	1 5/16" -12 ORB	3.93	2.17	1.80
1 1/4"	PVEP-114F-NPT-1-1/4"	1 1/4" NPTF	4.40	2.56	2.16
1 1/4"	PVEP-114F-SAE-1-5/8"	1 5/8" -12 ORB	4.40	2.56	2.16

Dust Cap For Coupler Half

SIZE	PART NUMBER
1/2"	PCV-1/2"-SC
3/4"	PCV-3/4"-SC
1"	PCV-1"-SC
1 1/4"	PCV-1 1/4"-SC

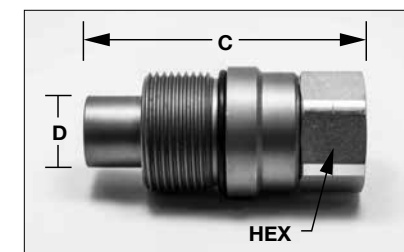

Plug

BODY SIZE	PART NUMBER		DIMENSIONS (IN.)		
	STEEL	THREAD SIZE	C	D	HEX
1/2"	PVEP-12M-NPT-1/2"	1/2" NPTF	3.75	1.80	1.42
1/2"	PVEP-12M-SAE-3/4"-16	3/4" -16 ORB	3.75	1.80	1.42
3/4"	PVEP-34M-NPT-3/4"	3/4" NPTF	3.90	1.92	1.42
3/4"	PVEP-34M-SAE-1-1/16"	1 1/16" -12 ORB	3.90	1.92	1.42
1"	PVEP-1M-NPT-1"	1" NPTF	4.47	2.12	1.80
1"	PVEP-1M-SAE-1-5/16"	1 5/16" -12 ORB	4.47	2.12	1.80
1 1/4"	PVEP-114M-NPT-1-1/4"	1 1/4" NPTF	4.86	2.52	2.16
1 1/4"	PVEP-114M-SAE-1-5/8"	1 5/8" -12 ORB	4.86	2.52	2.16

Dust Cap For Plug Half

SIZE	PART NUMBER
1/2"	PCV-1/2"-PC
3/4"	PCV-3/4"-PC
1"	PCV-1"-PC
1 1/4"	PCV-1 1/4"-PC



PVV Series

High Pressure Couplings

Features

- Up to 17,000 PSI working pressure
- Solid bar stock
- Connect/disconnect under pressure
- Polyurethane body seal

Applications

- Extreme pressure
- Hydraulic jacks
- High pressure test stands

Interchangeability

- Parker
- Faster
- Safeway
- Enerpac
- Dixon
- DNP
- Stucchi

Materials

- Steel
- 316 Stainless Steel

Sizes

- 1/4" - 3/8"

Temp. Rating

- -22°F to +230°F

Rated Pressure

- 10,000 PSI - Ball type - steel and 316 stainless steel
- 17,000 PSI - Poppet type - steel



Performance:

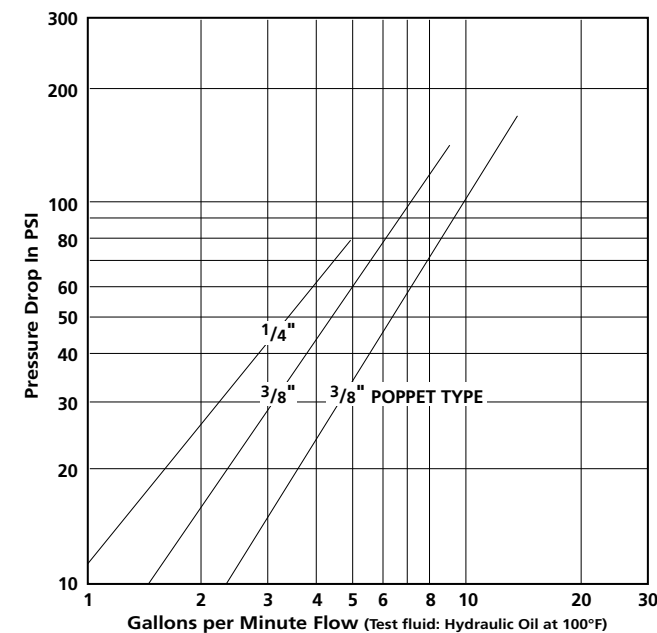

PVV Series

High Pressure Couplings

Ball Type (PVV)

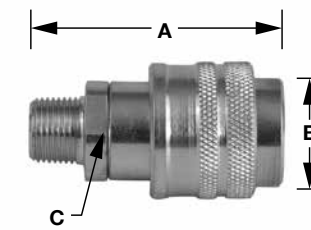

Poppet Type (PVVP)

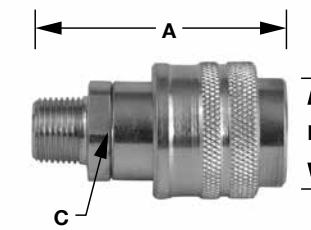

Coupler

BODY SIZE	PART NUMBER		THREAD	DIMENSIONS (IN.)		
	STEEL	STAINLESS		A	B	C
1/4"	PVV-14-F		1/4" NPTF	2.09	1.18	.87
3/8"	PVV-38-F	PVV-38-F-SS	3/8" NPTF	2.54	1.38	.95
3/8"	PVVP-38-F		3/8" NPTF	2.20	1.38	1.06

Dust Protector For Coupler (Aluminum)

SIZE	PART NUMBER
1/4"	TMP-14
3/8"	TMP-38

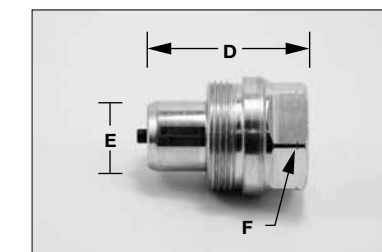
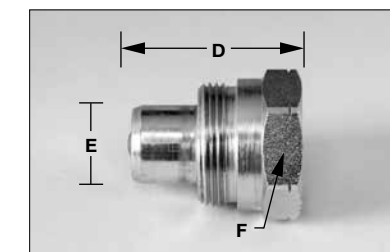
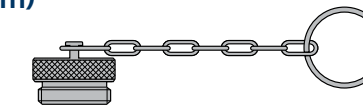

Plug

BODY SIZE	PART NUMBER		THREAD	DIMENSIONS (IN.)		
	STEEL	STAINLESS		D	E	F
1/4"	PVV-14-M		1/4" NPTF	1.54	.62	.75
3/8"	PVV-38-M	PVV-38-M-SS	3/8" NPTF	1.59	.75	1.26
3/8"	PVVP-38-M		3/8" NPTF	1.67	.75	.87

Dust Protector For Plug (Aluminum)

SIZE	PART NUMBER
1/4"	TFP-14
3/8"	TFP-38

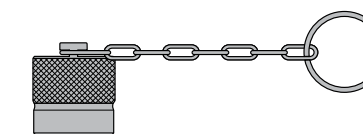

PC35 Series

High Pressure Couplings

Features

- 10,000 PSI working pressure
- Safety lock standard
- Slim profile
- 6 GPM rated flow
- Direct interchange to Parker TC Series and Eaton FD35 Series

Temp. Range

- -15°F to +400°F

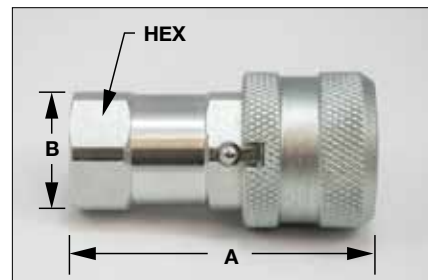

Coupler

BODY SIZE	THREAD	PART NUMBER	A	B	HEX
3/8"	3/8" NPT F	PC35-1001-06-06	2.46	1.27	.94

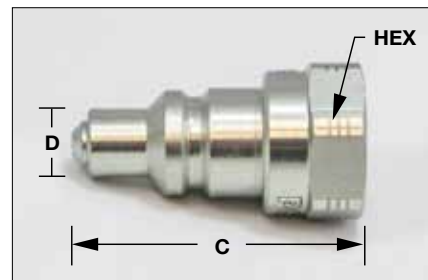

Plug

BODY SIZE	THREAD	PART NUMBER	C	D	HEX
3/8"	3/8" NPT F	PC35-1002-06-06	1.85	.44	.94

TNV/TNL Series

Valved and Non-Valved Couplings

Features

- High concentration of locking balls
- Heavy knurled sleeve
- Stainless steel spring, balls and retaining ring
- Buna-N O-Rings and Teflon backup rings

Applications

- General industry
- Construction
- Fluid transfer
- Transportation
- Chemical
- Oil and gas

Materials

- Steel

Sizes

- 1/4" - 2"

Temp. Rating

- -20°F to 215°F

Interchangeability

- Parker/Snap-Tite
- Dixon
- Faster



Performance:

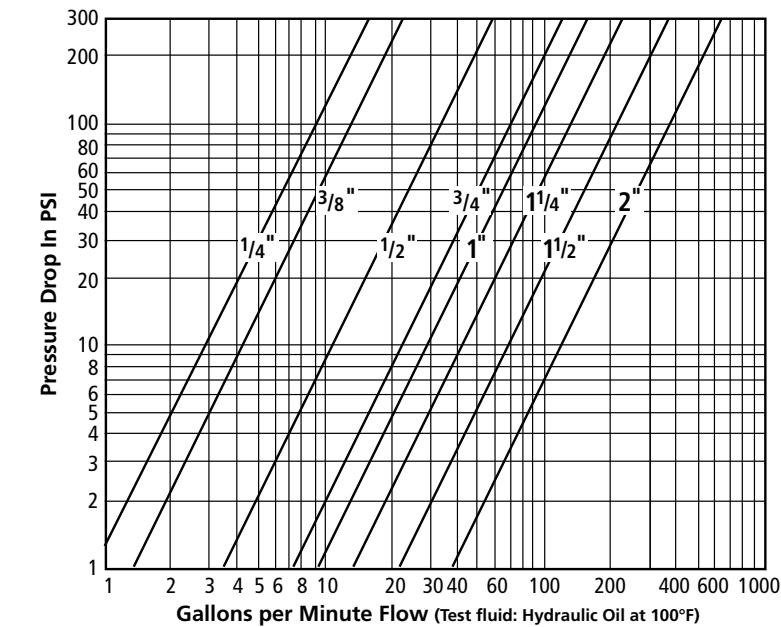

Rated Pressure (PSI) Valved

SIZE	STEEL
1/4"	6500
3/8"	4500
1/2"	4000
3/4"	3500
1"	2000
1 1/4"	1750
1 1/2"	1500
2"	1500

Rated Pressure (PSI) Non-Valved

SIZE	STEEL
1/4"	11,000
3/8"	11,000
1/2"	11,000
3/4"	9000
1"	6000

TNV Series

Valved Couplings

Coupler - Female Threads

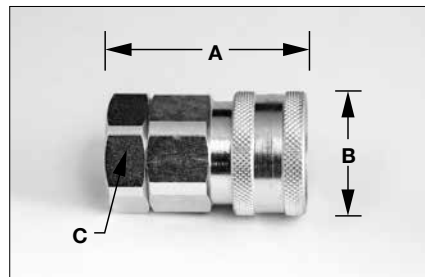

Coupler	PART NUMBER		DIMENSIONS (IN.)			
	BODY SIZE	STEEL	THREAD	A	B	C
	1/4"	TNV-04-F	1/4" NPTF	1.68	.99	.88
	3/8"	TNV-06-F	3/8" NPTF	1.94	1.18	1.00
	1/2"	TNV-08-F	1/2" NPTF	2.13	1.36	1.19
	3/4"	TNV-12-F	3/4" NPTF	2.47	1.67	1.50
	1"	TNV-16-F	1" NPTF	2.70	2.06	1.88
	1 1/4"	TNV-20-F	1 1/4" NPTF	3.54	2.19	2.00
	1 1/2"	TNV-24-F	1 1/2" NPTF	3.27	2.74	2.50
	2"	TNV-32-F	2" NPTF	3.83	3.83	3.50

Plug - Female Threads

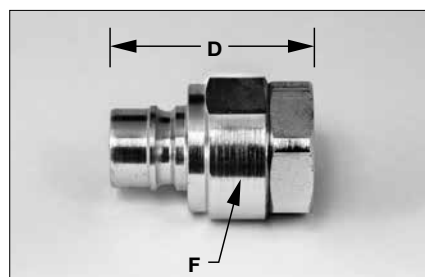

Plug	PART NUMBER		DIMENSIONS (IN.)		
	BODY SIZE	STEEL	THREAD	D	F
	1/4"	TNV-04-M	1/4" NPTF	1.62	.88
	3/8"	TNV-06-M	3/8" NPTF	1.87	1.00
	1/2"	TNV-08-M	1/2" NPTF	1.99	1.19
	3/4"	TNV-12-M	3/4" NPTF	2.31	1.50
	1"	TNV-16-M	1" NPTF	2.60	1.88
	1 1/4"	TNV-20-M	1 1/4" NPTF	3.41	2.00
	1 1/2"	TNV-24-M	1 1/2" NPTF	3.41	2.50
	2"	TNV-32-M	2" NPTF	3.72	3.50

TNL Series

Non-Valved Couplings

Coupler - Female Threads

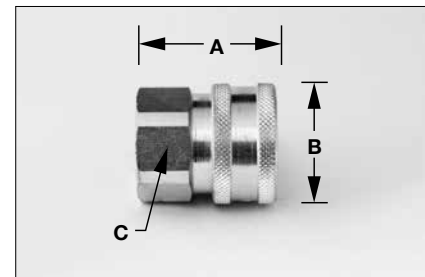

Coupler	PART NUMBER		DIMENSIONS (IN.)			
	BODY SIZE	STEEL	THREAD	A	B	C
	1/4"	TNL-04-F	1/4" NPTF	1.36	.99	.88
	3/8"	TNL-06-F	3/8" NPTF	1.50	1.18	.88
	1/2"	TNL-08-F	1/2" NPTF	1.64	1.37	1.19
	3/4"	TNL-12-F	3/4" NPTF	1.96	1.67	1.50
	1"	TNL-16-F	1" NPTF	2.10	1.99	1.81

Plug - Female Threads

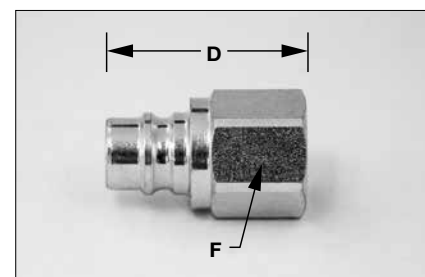

Plug	PART NUMBER		DIMENSIONS (IN.)		
	BODY SIZE	STEEL	THREAD	D	F
	1/4"	TNL-04-M	1/4" NPTF	1.27	.63
	3/8"	TNL-06-M	3/8" NPTF	1.41	.81
	1/2"	TNL-08-M	1/2" NPTF	1.72	1.00
	3/4"	TNL-12-M	3/4" NPTF	1.86	1.19
	1"	TNL-16-M	1" NPTF	2.08	1.50

ST Series

Non-Valved Couplings

Features

- Ball lock
- Manual operation
- Smooth bore permits free flow of liquid or gas

Applications

- General industry
- Fluid transfer
- Chemical
- Food and beverage
- Injection molding
- Marine
- Pressure wash

Interchangeability

- Parker
- Dixon
- Tomco
- Foster

Materials - Coupler

- Brass
- Stainless Steel

Materials - Plug

- Brass
- Steel
- Stainless Steel

Sizes

- 1/8" to 1"

Temp. Rating

- -40°F to 250°F



Rated Pressure In PSI

BODY SIZE	BRASS COUPLER BRASS PLUG	STAINLESS COUPLER STAINLESS PLUG	BRASS COUPLER STEEL PLUG
1/8"	2800	4200	3400
1/4"	5200	7500	5500
3/8"	2800	6300	4200
1/2"	2200	3600	3500
3/4"	1700	3000	2100
1"	1300	2000	2000

Performance:

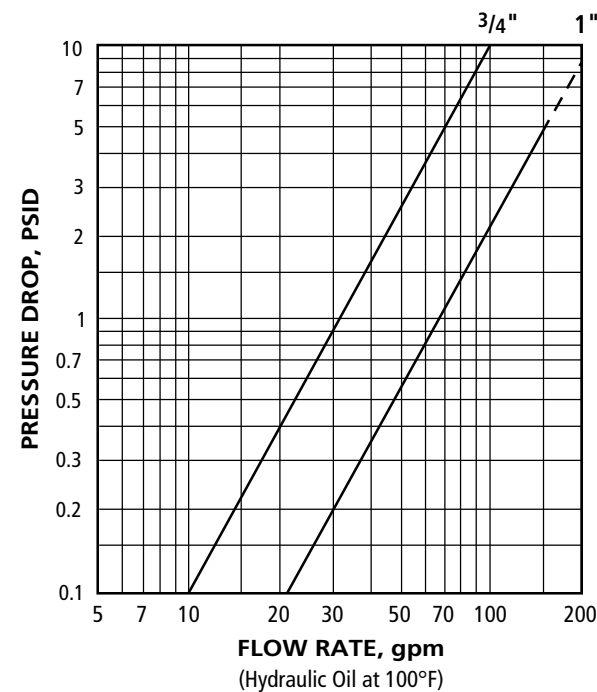
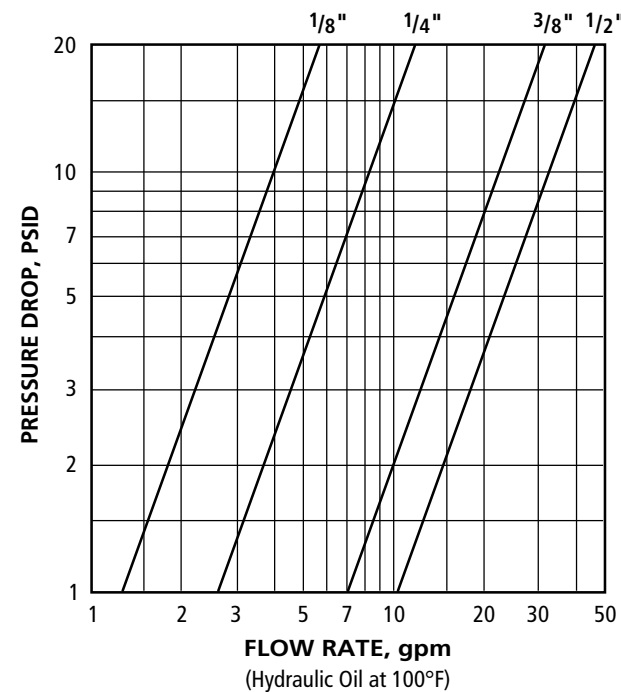

ST Series

Non-Valved Couplings

Female Threads

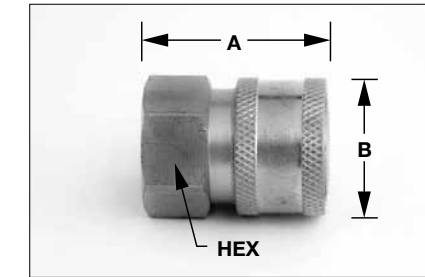

Coupler

BODY SIZE	PART NUMBER		THREAD SIZE	DIMENSIONS (IN.)		
	BRASS	STAINLESS STEEL		A	B	HEX
1/8"	B18FC	SS18FC	1/8" NPTF	1.06	.72	.56
1/4"	B14FC	SS14FC	1/4" NPTF	1.50	.97	.81
3/8"	B38FC	SS38FC	3/8" NPTF	1.59	1.16	1.00
1/2"	B12FC	SS12FC	1/2" NPTF	1.91	1.34	1.13
3/4"	B34FC	SS34FC	3/4" NPTF	2.06	1.72	1.44
1"	B1FC	SS1FC	1" NPTF	2.33	2.03	1.75

Male Threads

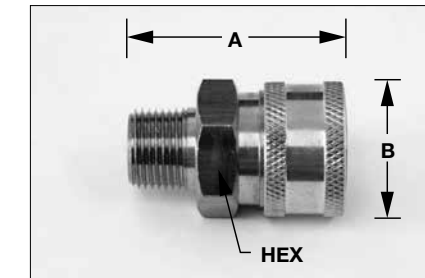

Coupler

BODY SIZE	PART NUMBER		THREAD SIZE	DIMENSIONS (IN.)		
	BRASS	STAINLESS STEEL		A	B	HEX
1/8"	B18MC	SS18MC	1/8" NPTF	1.06	.72	.56
1/4"	B14MC	SS14MC	1/4" NPTF	1.72	.97	.81
3/8"	B38MC	SS38MC	3/8" NPTF	1.75	1.16	1.00
1/2"	B12MC	SS12MC	1/2" NPTF	2.03	1.34	1.13
3/4"	B34MC	SS34MC	3/4" NPTF	2.22	1.72	1.44
1"	B1MC	SS1MC	1" NPTF	2.53	2.03	1.75

ST Series

Non-Valved Couplings

Female Threads

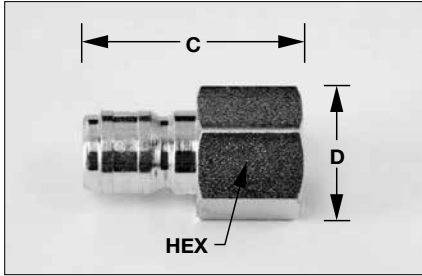

Plug

BODY SIZE	PART NUMBER			THREAD SIZE	DIMENSIONS (IN.)		
	BRASS	STEEL	STAINLESS STEEL		C	D	HEX
1/8"	B18FP	18FP	SS18FP	1/8" NPTF	.97	.58	.50
1/4"	B14FP	14FP	SS14FP	1/4" NPTF	1.45	.79	.69
3/8"	B38FP	38FP	SS38FP	3/8" NPTF	1.63	.94	.81
1/2"	B12FP	12FP	SS12FP	1/2" NPTF	1.92	1.15	1.00
3/4"	B34FP	34FP	SS34FP	3/4" NPTF	2.01	1.37	1.19
1"	B1FP	1FP	SS1FP	1" NPTF	2.21	1.80	1.56

Male Threads

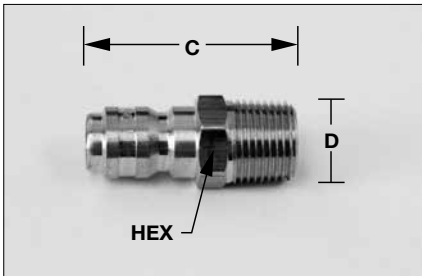

Plug

BODY SIZE	PART NUMBER			THREAD SIZE	DIMENSIONS (IN.)		
	BRASS	STEEL	STAINLESS STEEL		C	D	HEX
1/8"	B18MP	18MP	SS18MP	1/8" NPTF	1.06	.51	.44
1/4"	B14MP	14MP	SS14MP	1/4" NPTF	1.56	.65	.56
3/8"	B38MP	38MP	SS38MP	3/8" NPTF	1.69	.79	.69
1/2"	B12MP	12MP	SS12MP	1/2" NPTF	2.01	1.01	.88
3/4"	B34MP	34MP	SS34MP	3/4" NPTF	2.20	1.23	1.06
1"	B1MP	1MP	SS1MP	1" NPTF	2.49	1.59	1.38